

Article number: 0106062

Description: Retaining ring JV 45

## Measures

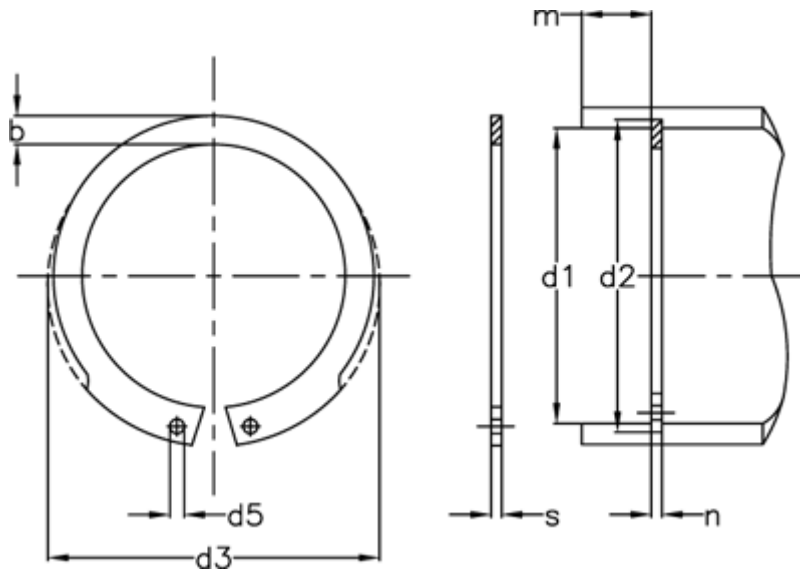

AN mm <sup>2</sup>	= 90	FRg kN	= 8.4	tol	= 0.2
b	= 4.2	FR kN	= 44.0	tol	= -0.06
d1	= 45	g	= 2.0	tol	= +0,90-0,39
d2	= 47.5	K kN-mm	= 79.5	tol	= +0,25
d3	= 48.5	m min	= 1.85	Tong	= ZGJ-2
d5 min	= 2.0	Nominal drive	= 3.8	Weight kg/1000	= 6.00
Description	= JV 45	s	= 1.75		
FN kN	= 15.00	t	= 1.25		